

IMMERSION BLENDERS
SALAD SPINNERS
FOOD CUTTERS
JUICER

2015-2016 PRODUCT CATALOG

dynamicmixersusa.com
dynamicmixers.ca
facebook.com/dynamicmixers

Terms and conditions

Freight Prepaid qualifies at \$2,750 net on individual orders shipped to one location (Power Pro Giraffe excluded, call for freight quote). Additionally, a flat \$50 fee applies per pallet on individual orders that include a minimum of 15 Salad Spinners to a maximum of 30 Salad Spinners regardless of value of order including Freight Prepaid criteria.

Orders not meeting our Freight Prepaid criteria are F.O.B. Memphis, TN (USA) and Montreal, Que. (Canada).

Returned Goods are not accepted without the written consent of Dynamic. Merchandise must be returned within 10 days after receipt of invoice.

25% restocking charge will apply on returned merchandise. Used and or damaged merchandise and products deemed "Special Order" are non-returnable.

All products sold remain the exclusive property of Dynamic until invoice is paid in full.

No minimum orders.

To request a copy of our "Product Returns & Invoicing" Policy, please call 1 (800) 267-7794 or email us at info@dynamicmixers.com.

Warranty Policy

Dynamic will guarantee all new Dynamic products to be free from defects in materials & workmanship. Electric products - Includes a 1 year parts and labor carry in bench warranty; with the exception of component replacements necessary through regular "wear & tear". Manual products include a 1 year limited parts warranty. Warranty is valid, providing the products have been used in accordance with Dynamic's operating recommendations & guidelines. Dynamic or any authorized service center will repair or replace, at our discretion and after examination, any or all manufacturer's defective parts during the warranty period. Any damage caused by improper use, abuse, dropping, or similar accidental damage resulting in breakage will render the warranty null and void. During the warranty period, only Dynamic or one of its authorized service centers may perform evaluations or repairs to products. Warranty will be void on any equipment which has been dismantled or tampered with during this warranty period if this has been done by unauthorized centers or personnel.

Disclaimer

Specifics contained herein with regards to product text and/or product images may change without notice.



Demand the Best. Demand Dynamic.

Dynamic is the inventor and industry leader of the Immersion Blender, Salad Spinner and the number one dicer in the world, the Dynacube. Manufacturing quality foodservice equipment for over 50 years, the engineers at Dynamic continue the tradition of in-house manufacturing of all components that make up each piece of equipment. This corporate strategy ensures product quality at the factory level allowing a comprehensive warranty and our goal of sustaining the highest level of customer service.

From the Minipro to the Power Pro Giraffe, Dynamic offers the most diversified Immersion Blender line up in the foodservice industry. With our Manual and Electric Salad Spinners, we cover your lettuce drying needs. The Dynacube Manual dicer is the number one food dicer in the world. Safe and efficient with a patented cutting system that will increase your yield, lower your food cost and offer food prep consistency second to none.

It will be our pleasure to serve you and assist in enhancing your foodservice equipment needs. Feel free to contact us anytime at your convenience.



MINI

MINI see pages 8-9

01	Minipro	200 W
02	Dynashake	200 W
03	Mini Cordless Whisk	180 W
04	Mini Cordless Mixer	180 W
05	MD95	180 W
06	Minipro Motor Block	200 W
07	Minipro Mixer Tool	
08	Dynashake Mixer Tool	
09	Minipro Whisk Tool	
10	Minipro Ricer/Foodmill	
11	Minipro Processor Bowl	
12	Minipro Stainless Steel Cup	

Mixers
1 - 12 L
0.25 / 3 gal.

Whisk
1 - 5 L
0.25 / 1.25 gal.



MASTER p.14-15-16

01	MX91	460 W	06	M90 Mixer Tool
02	MX2000	460 W	07	M100 Mixer Tool
03	MDH2000	460 W	08	F90 Whisk Tool
04	MDH3000 NEW	550 W	09	FM Whip
05A	BM2000 Motor Block	460 W	10	AP90 Ricer/Foodmill
05B	BM3000 Motor Block	550 W	11	Dynacutter Bowl

See Master Combi Mixers on page 16



JUNIOR

JUNIOR see pages 10-11

01	Junior Standard	200 W
02+03	Junior Plus	200 W
02+03+04	Junior Combi	200 W
02	Junior Motor Block	200 W
03	Junior Mixer Tool	
04	Junior Whisk Tool	
05	Junior Ricer/Foodmill	
06	Junior Processor Bowl	

Mixers
5 - 25 L
1.25 / 6.5 gal.

Whisk
1 - 5 L
0.25 / 1.25 gal.

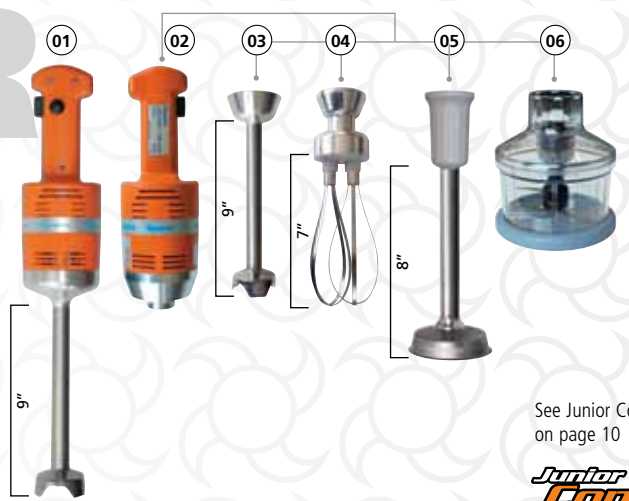

See Junior Combi on page 10



SENIOR

SENIOR see pages 12-13

01	PMX98	300 W
02+03	PMDH250	300 W
02+03+04	Senior Combi PMF250	300 W
02	Senior Motor Block	300 W
03	Senior Mixer Tool	
04	Senior Whisk Tool	
05	Senior Ricer/Foodmill	
06	Senior Processor Bowl	

Mixers
20 - 40 L
5 / 10 gal.

Whisk
5 - 20 L
1 / 5 gal.

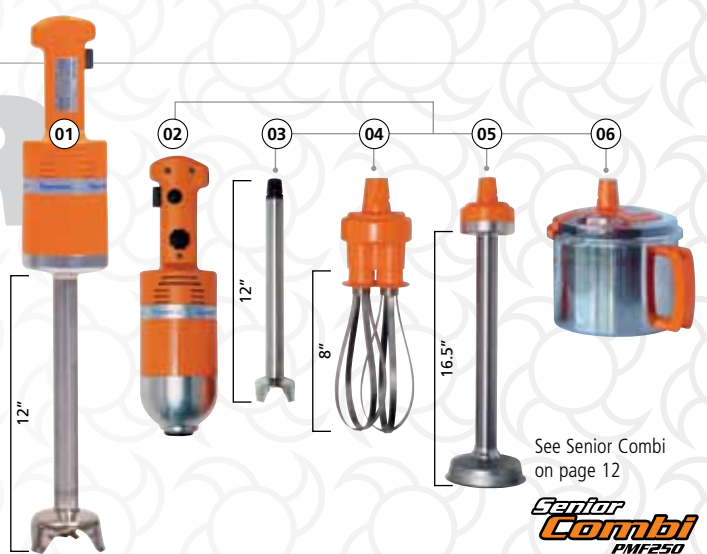

See Senior Combi on page 12



SMX see page 17

01	SMX600E	650 W
02	SMX700E NEW	700 W
03	SMX800E	800 W
04	Brackets	



SMIX

SPECIALTY MIXERS

SPECIALTY p. 18

01	Junior Whisk	200 W
02	Master Whisk FT97	460 W
03	PP97 Ricer/Foodmill	460 W
04	PP97 Plus	460 W
05	FM97 Whisk Tool	



SALAD SPINNERS



SALAD SPINNERS p. 22

01	SD99 Manual	2.5 gal / 10 L
02	SD92 Manual	5 gal / 20 L
03	SD925C Sealed Cover Manual	5 gal / 20 L
04	EM98 Electric	5 gal / 20 L
05	SSB1 Stabilizing Base	

POWER PRO GIRAFFE

Power Pro Giraffe p. 20-21

01	Power Pro Giraffe Mixer	1500 W
----	-------------------------	--------



FOOD CUTTERS

DYNACUBE



FOOD CUTTERS see page 23

01	Dynacube Manual Dicer
02	Dynacube Manual Slicer / Shredder



MORE

MORE see page 19

01	Citrus Juicer
02	Safety Cones





MiniPro DynaShake

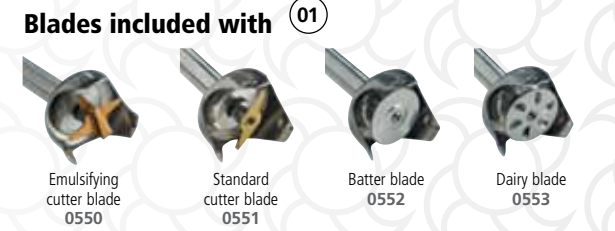

01 - MiniPro detachable shaft + all blades MiniPro comes complete with : 1 MiniPro Mixer + 1 emulsifying blade + 1 standard blade + 1 batter blade + 1 dairy blade	MX070.1
Total length: 395 mm / 15,5" Shaft length: 160 mm / 6,5" Diameter: 70 mm / 2,8" Actual / shipping weight: 0,990 Kg / 2,20 lbs Output: 200 W Speed: 0 to 13000 R.P.M.	4 blades included
02 - Dynashake detachable shaft + all blades + graduated cup with lid Dynashake comes complete with: 1 Dynashake Mixer + 1 emulsifying blade + 1 standard blade + 1 batter blade + 1 dairy blade + a 1 litre graduated cup + lid	MX054.1
Total length: 425 mm / 16,7" Shaft length: 190 mm / 7,5" Diameter: 95 mm / 3,8" Actual / shipping weight: 1,4 Kg / 3 lbs Output: 200 W Speed: 0 to 13000 R.P.M.	4 blades and 1 Graduated cup with lid included
03 - MD 95 Standard blade	MX010.1
03 - MD 95 E Emulsifying blade	MX008.1
Total length: 445 mm / 17,5" Mixer tool length: 160 mm / 7" Diameter: 72 mm / 3" Actual / shipping weight: 1,2 Kg / 2,6 lbs - 1,5 Kg / 3,3 lbs Output: 180 W Speed: 9500 R.P.M.	
Option : variable speed control	MX010.1.V

04 - Mini cordless mixer Standard blade	MX011.1
04 - Mini cordless mixer Emulsifying blade	MX014.1
Total length: 460 mm / 18,5" Mixer tool length: 160 mm / 7" Diameter: 72 mm / 3" Actual / shipping weight: 1,4 Kg / 3,0 lbs - 3,0 Kg / 6,6 lbs Output: 180 W Speed: 7000 R.P.M.	2 Batteries and charger included
05 - Mini cordless whisk	FT003.1
Total length: 445 mm / 17,5" Mixer tool length: 185 mm / 7,5" Diameter: 72 mm / 3" Actual / shipping weight: 1,5 Kg / 3,3 lbs - 3,0 Kg / 6,6 lbs Output: 180 W Speed: 700 R.P.M.	2 Batteries and charger included
06 - Battery - 1hr. charge, 1hr. run time	AC111
07 - Battery charger	AC110.1
08 - Emulsifying blade	9414



01- Standard motor block	AC515.1
02- Minipro mixer tool with emulsifying blade	AC520
03- Dynashake mixer tool with emulsifying blade	AC530
04- Whisk tool Capacity: 1-5 L	AC516
05- Foodmill ricer Capacity: 10 lbs	AC517
06- Minipro food processor bowl Capacity: 0.8 L / 1 qt.	AC518
07- Graduated cup with lid 1 L / 40 oz. + cover	AC510
08- Minipro Stainless steel cup	AC513



A truly professional mixer for small preparations!

The Mini Series is the smallest, lightest, most diversified commercial line up of Immersion Blenders in the foodservice industry. Whether corded or battery operated these are perfect for small mixing applications and replenishing batches of your favourite soups, sauces and dressings.

Unique cutter blades and preparation discs along with attachments like the Food Mill/Ricer and the Food Processor Bowl simplify your preparation needs and minimize your kitchen clutter.

The Mini Series.....Quality, durability and flexibility you can count on at a fraction of the cost you would expect.



**Junior
Combi**

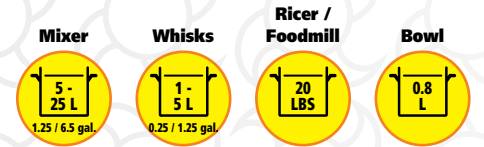

01 - Junior motor block	AC100.1
Total length: 305 mm / 12"	
Diameter: 94 mm / 4"	
Actual / shipping weight: 1,9 Kg / 4 lbs - 2,3 Kg / 5 lbs	
Output: 250 W	
Speed: 0 to 9500 R.P.M.	
02 - Junior mixer tool	AC101
03 - Junior whisk tool	AC102
04 - Junior ricer/foodmill	AC103
05 - Junior processor bowl	AC104

01 - Junior standard non-detachable	MX020.1
Total length: 505 mm / 20"	
Mixer tool length: 225 mm / 9"	
Diameter: 94 mm / 4"	
Actual / shipping weight: 1,7 Kg / 3,7 lbs - 2,0 Kg / 4,4 lbs	
Output: 250 W	
Speed: 9500 R.P.M.	
Option : variable speed control	MX020.1.V
02 - Junior plus detachable	MX021.1.V
Total length: 505 mm / 20"	
Mixer tool length: 225 mm / 9"	
Diameter: 94 mm / 4"	
Actual / shipping weight: 1,9 Kg / 4,2 lbs - 2,3 Kg / 5 lbs	
Output: 250 W	
Speed: 0 to 9500 R.P.M.	

03 - Junior combi detachable	MX022.1
Total length: 530 mm / 21"	
Mixer tool length: 225 mm / 9"	
Whisk length: 185 mm / 7,5"	
Diameter: 94 mm / 4"	
Actual / shipping weight: 2,4 Kg / 5,3 lbs - 3,3 Kg / 7,3 lbs	
Output: 250 W	
Mixer / Whisk speed: 0 to 9500 R.P.M. / 0 to 2000 R.P.M.	
04 - Emulsifying blade	4009



Light and easy to use, with a capacity of 25L / 6.5 gal.

The Junior Series takes care of your small food preparation needs. This light duty series is great for soups, gravies and your favourite everyday sauces.

Available with both detachable and non detachable shafts and a selection of convenient attachments; your menu is covered from start to finish. The Food Processor Bowl attachment is perfect for nuts and parsley and more importantly eliminates the need for a conventional food processor.

The Junior Series is lightweight, efficient and dependable allowing uninterrupted, consistent everyday mixing.



Senior Combi
PMF250

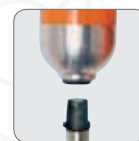

Precise alignment of motor block and mixer tool requires only a 1/4 turn to secure.



Ejectable whisks for easy cleaning.



01 - Senior motor block BM 250 300 watts motor block can be used with the mixer tool and whisk attachment.	AC005.1
Total length: 330 mm / 13"	
Diameter: 97 mm / 4"	
Actual / shipping weight: 2,0 Kg / 4,4 lbs - 3,1 Kg / 6,8 lbs	
Output: 300 W	
Speed: 0 to 9500 R.P.M.	
02 - Senior mixer tool M 250	AC006
03 - Senior ricer/foodmill	AC004
04 - Senior whisk F 250	AC007
05 - Senior processor bowl	AC055
06 - Serrated blade for Dynacutter	AC056

01- PMX 98 standard non-detachable	MX007.1
Total length: 600 mm / 24"	
Mixer tool length: 300 mm / 12"	
Diameter: 97 mm / 4"	
Actual / shipping weight: 2,4 Kg / 5,3 lbs - 2,9 Kg / 6,4 lbs	
Output: 300 W	
Speed: 9500 R.P.M.	
Option : variable speed control	MX007.1.V
02- PMDH 250 detachable	MX006.1
Total length: 640 mm / 25"	
Mixer tool length: 300 mm / 12"	
Diameter: 97 mm / 4"	
Actual / shipping weight: 2,5 Kg / 5,5 lbs - 3,7 Kg / 8,1 lbs	
Output: 300 W	
Speed: 0 to 9500 R.P.M.	

03- PMF 250 Senior combi	MF003.1
Total length: 640 mm / 25"	
Mixer tool length: 300 mm / 12"	
Whisk length: 205 mm / 8"	
Diameter: 97 mm / 4"	
Actual / shipping weight: 3,4 Kg / 7,5 lbs - 4,5 Kg / 9,9 lbs	
Output: 300 W	
Mixer / Whisk Speed: 0 to 9500 R.P.M. - 0 to 900 R.P.M.	

Ref. 0880



Convenient and secure :
Wall storage bracket for mixer and accessories included.



Power and versatility for medium recipes.

The Senior Series is perfect for medium sized mixing applications. With a precise power to weight ratio and the versatility of multiple attachments, the Senior Series makes the task of preparing your favourite recipes fun and easy.

The Foodmill/Ricer attachment will make the preparation of potatoes quick and easy and eliminate the need for unnecessary equipment and supplies. With a variable speed option both standard and available, perfecting delicate recipes are a reality.

The Senior line developed and introduced almost 20 years ago is a staple in commercial kitchens around the world and continues the tradition of supporting fine foodservice establishments.

Master Series

Master Series Accessories



01 - MX 91 "Classic" non-detachable	MX005.1
Total length: 715 mm / 28"	
Mixer tool length: 410 mm / 16"	
Diameter: 110 mm / 4,5"	
Actual / shipping weight: 3,4 Kg / 7,5 lbs - 3,8 Kg / 8,4 lbs	
Output: 460 W	
Speed: 9000 R.P.M.	
Option : variable speed control	MX005.1.V
02 - MX 2000 non-detachable	MX004.1
Total length: 720 mm / 28,5"	
Mixer tool length: 410 mm / 16"	
Diameter: 122 mm / 5"	
Actual / shipping weight: 3,5 Kg / 7,7 lbs - 4,1 Kg / 9 lbs	
Output: 460 W	
Speed: 0 to 9500 R.P.M.	
Option : variable speed control	MX004.1.V
03 - MDH 2000 detachable mixer	MX003.1
Total length: 720 mm / 30"	
Mixer tool length: 410 mm / 16"	
Diameter: 122 mm / 5"	
Actual / shipping weight: 3,7 Kg / 8,1 lbs - 4,5 Kg / 9,9 lbs	
Output: 460 W	
Speed: 0 to 9500 R.P.M.	
04 - MDH 3000 detachable mixer <i>NEW</i>	MX013.1
Total length: 840 mm / 33"	
Mixer tool length: 457mm / 18"	
Diameter: 122mm / 5"	
Actual / shipping weight: 4.5 kg / 10 lbs - 5 kg / 11 lbs	
Output: 550W	
Speed: 0 to 9500 R.P.M.	
05 - Emulsifying cutter blade	7910



Continuous function auto run button also allows to mix continuously by pulse.



01A - BM 2000 motor block	AC001.1
Length: 350 mm / 13,75"	
Diameter: 122 mm / 4,75"	
Weight: 2,7 Kg / 6,0 lbs	
Output: 460 W	
Speed: 0 to 9500 R.P.M. with variable speed	
01B - BM 3000 motor block	AC001.1.A
Length: 350 mm / 13,75"	
Diameter: 122 mm / 4,75"	
Weight: 2,7 Kg / 6,0 lbs	
Output: 550 W	
Speed: 0 to 9500 R.P.M. with variable speed	
02 - M90 Mixer tool attachment. Weight: 1 Kg / 2,2 lbs	AC002
03 - M100 Mixer tool attachment.	AC500
04 - F90 whisk attachment. Weight: 0.9 Kg / 2,0 lbs.	AC003
Speed: 0 to 900 R.P.M. with variable speed	
05 - Master whip FM 1	AC202
06 - Master whip FM 2	AC200
07 - Master whip FM 3	AC201
Length FM 1: 420 mm / 16,5"	
Length FM 2: 600 mm / 24"	
Length FM 3: 700 mm / 28"	
Speed: 0 to 500 R.P.M.	
All stainless steel, handle support included.	
08 - AP 90 foodmill / ricer	AC004
Diameter grid: 110 mm / 4,3"	
Weight: 1,9 Kg / 4,2 lbs	
Speed: 0 to 600 R.P.M. with variable speed	
09 - Dynacutter bowl complete The complete Dynacutter bowl includes a 5 liters / 6 qts - bowl, cover, reducer and a standard blade or serrated blade.	AC055
10 - Serrated blade for Dynacutter	AC056

The most advanced and versatile series in the industry.

The Master Series is the longest running series in the Dynamic line up. Introduced almost 50 years ago, this was the first ever Immersion Blender introduced to the foodservice industry and continues to be the number one series in the world.

Capable of large capacities and medium to heavy duty product mixing; this lightweight series adds convenience and flexibility with its numerous attachment options. The only Immersion blender available with a Balloon Whip attachment available in 3 lengths, allows stirring as well as mixing for those precise recipes. One motor block with numerous attachment options, simplifies your preparation set up and more importantly lowers your overall equipment costs.

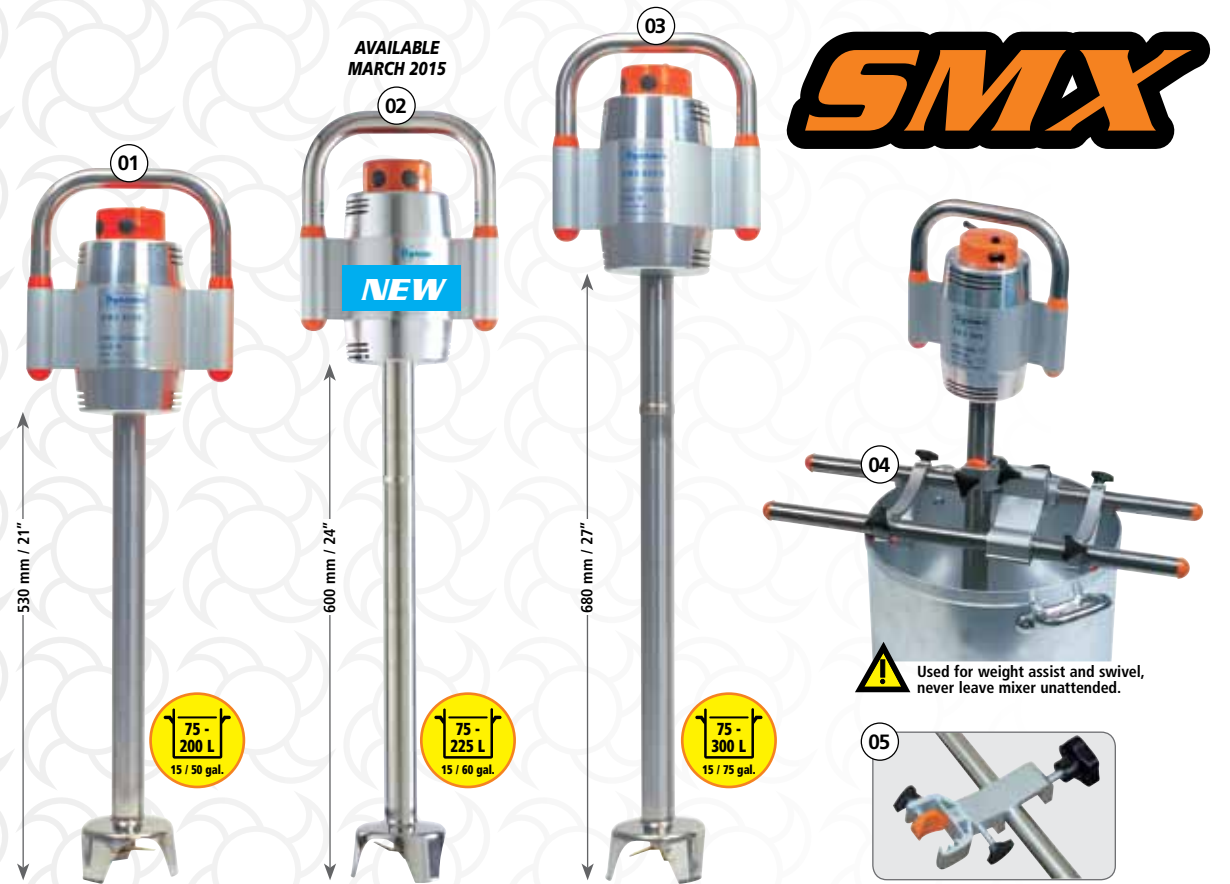

Ref. 0880



Convenient and secure :
Wall storage bracket for mixer and accessories included.



Continuous function auto run button allows to mix continuously or by pulse.



Ejectable whisks for easy cleaning.



Stainless steel perforated grid and blade can be easily dismantled for cleaning.



01 - Master combi 1 MF2000 (mixer tool + whisk)	MF002.1
Total length: 753 mm / 30"	
Mixer tool length: 410 mm / 16"	
Whisk length: 245 mm / 10"	
Diameter: 122 mm / 5"	
Actual / shipping weight: 4,5 Kg / 9,9 lbs - 6,3 Kg / 3,9 lbs	
Output: 460 W	
Mixer / Whisks Speed: 0 to 9500 - 0 to 900 R.P.M.	
02 - Master combi 2 MFAP 2000 detachable (mixer tool + whisk + ricer)	MF001.1
Total length: 753 mm / 30"	
Mixer tool length: 410 mm / 16"	
Whisk length: 245 mm / 10"	
Length and diameter of ricer / foodmill: ... 420 mm - 110 mm / 16,5" - 4,5"	
Diameter: 122 mm / 5"	
Actual / shipping weight: 6,5 Kg / 14,3 lbs - 8,4 Kg / 18,5 lbs	
Output: 460 W	
Mixer Speed: 0 to 9500 R.P.M.	
Whisk Speed: 0 to 900 R.P.M.	
Foodmill / Ricer Speed: 0 to 600 R.P.M.	

01 - SMX600E non detachable	MX002.1
Total length: 800 mm / 31,5"	
Diameter: 125 mm / 5"	
Actual / shipping weight: 6,1 Kg / 13,4 lbs - 7,7 Kg / 17 lbs	
Output: 650 W	
Speed: 9500 R.P.M.	
02 - SMX700E (detachable for maintenance only)	MX040.1
Total length: 870 mm / 24"	
Diameter: 125 mm / 5"	
Actual / shipping weight: 6,5 Kg / 14,3 lbs - 8 Kg / 17,6 lbs	
Output: 700 W	
Speed: 9500 R.P.M.	
03 - SMX800E (detachable for maintenance only)	MX001.1
Total length: 950 mm / 37,5"	
Diameter: 125 mm / 5"	
Actual / shipping weight: 6,7 Kg / 14,7 lbs - 8,2 Kg / 18 lbs	
Output: 800 W	
Speed: 9500 R.P.M.	

Brackets

They are easily dismantled and can be cleaned in the dishwasher. Adaptable for all series of mixers. Adjustable length. Practical and convenient, allows adjustable height and angle.

04 - SM 4 Top mounted	SM001
Support brackets maximum dimension: 400 mm / 16"	
Weight: 1,9 Kg / 4,2 lbs	
04 - SM 6 Top mounted	SM002
Support brackets maximum dimension: 600 mm / 24"	
Weight: 2,3 Kg / 5 lbs	
04 - SM 8 Top mounted	SM003
Support brackets maximum dimension: 800 mm / 32"	
Weight: 2,6 Kg / 5,7 lbs	
04 - SM 10 Top mounted	SM004
Support brackets maximum dimension: 1000 mm / 40"	
Weight: 2,8 Kg / 6,2 lbs	
04 - SM 12 Top mounted	SM005
Support brackets maximum dimension : 1200 mm / 48"	
Weight: 3,2 Kg / 7 lbs	
05 - SA Side mounted	SM006
Support brackets "side mounting"	
Weight: 0,7 Kg / 1,5 lbs	



PA96

PA96 citrus juicer	PA001.1
Total height:	330 mm / 13"
Diameter:	220 mm / 8,6"
Weight:	6,3 Kg / 13,9 lbs
Voltage:	115 V or 230 V
Output max:	200 W
Speed:	1500 R.P.M.

The PA96 Citrus juicer is quiet and sturdy. It runs at 1500 R.P.M. and is great for juicing lemons, limes, oranges and grapefruit. All easy to clean components.



01 - Junior whisk non-detachable	FT005.1
Total length:	500 mm / 20"
Whisk tool length:	185 mm / 7,5"
Diameter:	94 mm / 4"
Actual / shipping weight:	1,4 Kg / 3 lbs - 1,7 Kg / 3,7 lbs
Output:	200 W
Speed:	0 to 2000 R.P.M.
02 - FT 97 Master whisk non-detachable	FT001.1
Total length:	650 mm / 25,5"
Whisk tool length:	245 mm / 10"
Diameter:	110 mm / 4,5"
Actual / shipping weight:	3,3 Kg / 7,3 lbs - 3,7 Kg / 8,1 lbs
Output:	460 W
Speed:	0 to 900 R.P.M.
03 - PP 97 ricer / foodmill non detachable	PP001.1
04 - PP 97 Plus ricer / foodmill detachable	PP002.1
Total length (PP97 / PP97+):	870 - 920 mm / 34" - 36"
Mixer tool length (PP97 / PP97+):	520 - 570 mm / 20,5" - 22,5"
Diameter:	170 mm / 6,75"
Actual / shipping weight:	4,9 Kg / 10,7 lbs - 5,9 Kg / 13 lbs
Output:	460 W
Speed PP97 - PP97+:	0 R.P.M. - 0 to 500 R.P.M.
05 - FM 97 whisk tool (For PP97 Plus)	AC208
Length: 690 mm / 27" - Weight: 1,5 Kg / 3,3 lbs - Capacity: 40 to 100 l. - comes with handle	



Stainless steel perforated grid and blade can be easily dismantled for cleaning.



Safety Cones



Safety cones - Trilingual : English / Spanish / French.	
01 - BS 50 W Wet floor cones - Height 500 mm / 19"	BS001
02 - BS 75 W Wet floor cones - Height 750 mm / 29,5"	BS004

Power Pro Giraffe

HEAVY DUTY MOBILE MIXER



Heavy Duty Mobile Mixer for large capacity applications.

The Power Pro Giraffe is designed for your high volume, heavy duty mixing duties. Stainless steel construction guarantees many years of sanitary, uninterrupted food preparation. Constructed with heavy duty locking casters and tilting mechanism allows for easy transport, safe and secure operation and convenient storage.

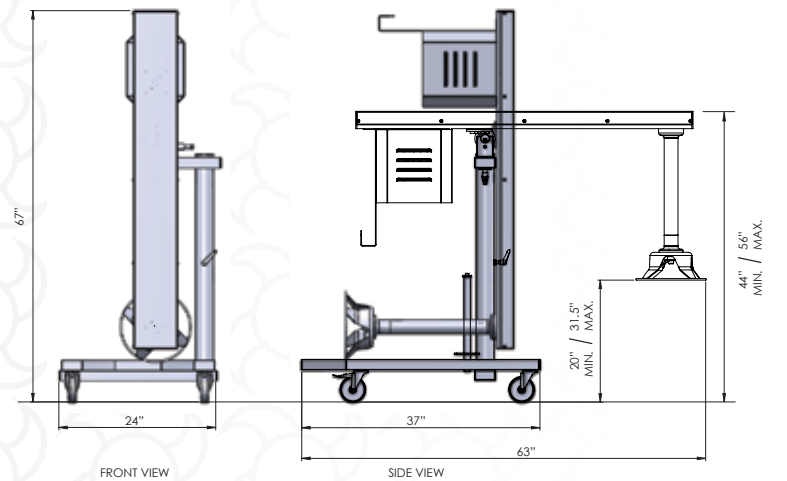

01 - Standard cutter blade attachment
02 - Whip attachment (sold separately)
03 - Blender attachment (sold separately)

01 - Power Pro Giraffe with standard cutter blade attachment and variable speed	TB002
Electrical specifications:	
Voltage: 230 V, 3 phase, 50/60Hz (Other voltage upon request)	
Power output:1500 W	
Speed : 0 - 4000 R.P.M.	
Thermal magnetic circuit breaker	
Standard cutter blade attachment:	
Diameter: 280 mm / 11"	
Height: 160 mm / 6.5"	
02 - Whip attachment	TB003
The whip attachment is ideal for delicate recipes. It provides the ultimate in mixing flexibility.	
Diameter: 170 mm / 6.5"	
Height: 470 mm / 18.5"	
03 - Blender attachment NEW	TB004
The new blender attachment is ideal to emulsify soups or sauces.	
Diameter: 100 mm / 3.75"	
Height: 90 mm / 3.5"	

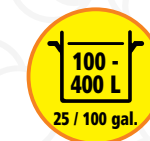

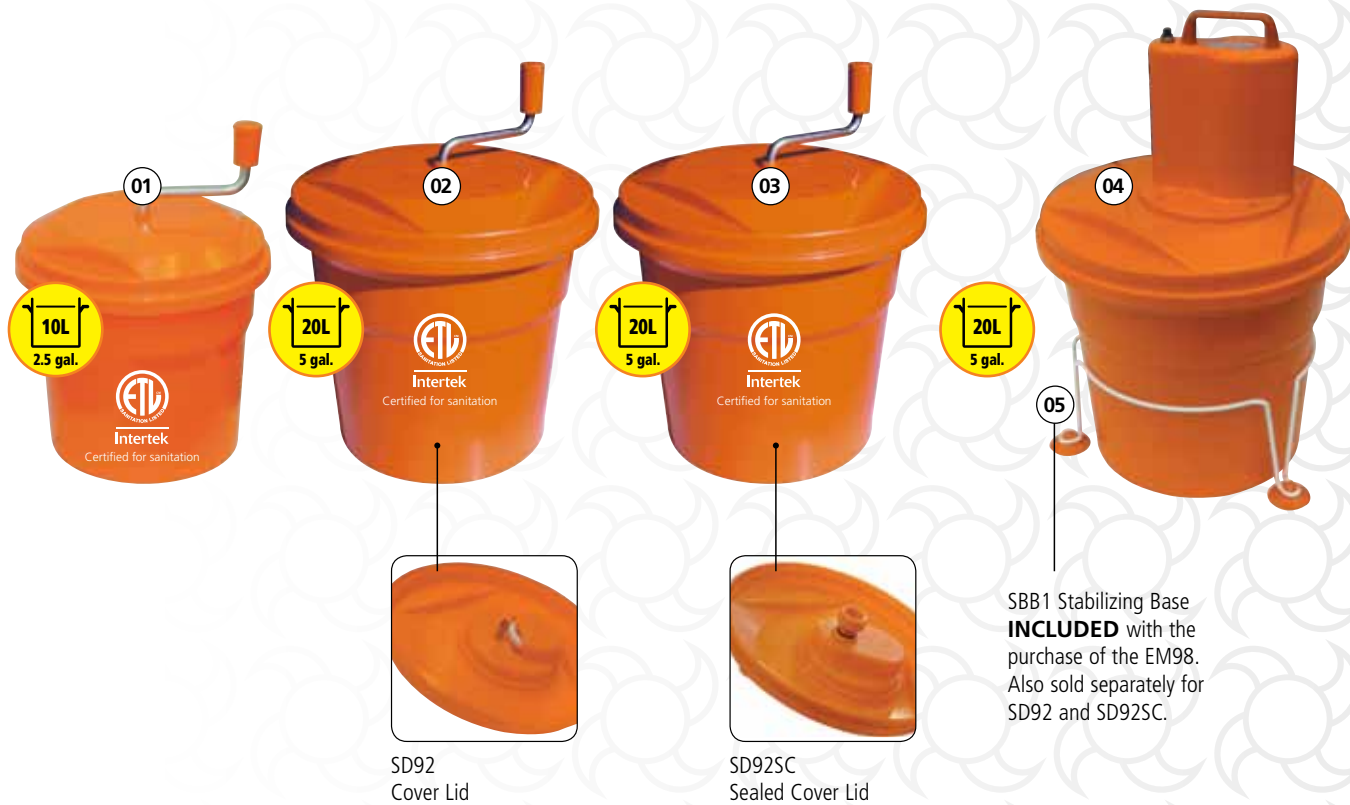

10L
2.5 gal.

20L
5 gal.

20L
5 gal.

20L
5 gal.

SD92
Cover Lid

SD92SC
Sealed Cover Lid

SBB1 Stabilizing Base
INCLUDED with the purchase of the EM98.
Also sold separately for SD92 and SD92SC.

Dynamic, the inventor of the Commercial Salad Spinner.

With the largest selection of Salad Spinners in the foodservice industry, from Manual to Electric versions and 2.5 gallon to 5 gallon capacities, Dynamic has your lettuce drying needs covered.

With innovation always at the forefront, we manufacture a Stabilizing Base option that decreases your drying time thus increasing your productivity.

Washing and drying your lettuce has a positive affect on your food cost and above all promotes a healthy choice.

01 - SD 99 Manual salad spinner	E001
Diameter: 330 mm / 13"	
Total height: 420 mm / 18"	
Actual / shipping weight: 2,4 Kg / 5,3 lbs - 3,1 Kg / 6,8 lbs	
Maximum of 4 heads of lettuce	
02 - SD 92 Manual salad spinner	E002
Diameter: 430 mm / 17"	
Total height: 500 mm / 21"	
Actual / shipping weight: 3,6 Kg / 7,9 lbs - 4,8 Kg / 10,5 lbs	
Maximum of 8 heads of lettuce	
03 - SD 92 Manual salad spinner SEALED COVER	E004
Diameter: 430 mm / 17"	
Total height: 500 mm / 21"	
Actual / shipping weight: 3,6 Kg / 7,9 lbs - 4,8 Kg / 10,5 lbs	
Maximum of 8 heads of lettuce	
04 - EM 98 electric salad spinner with stabilizing base SSB1	E003.1.B
Total height: 630 mm / 25"	
Diameter: 430 mm / 17"	
Actual / shipping weight: 8,3 Kg / 18,3 lbs - 10 Kg / 22 lbs	
Output: 200 W	
Speed: 500 R.P.M.	
Maximum of 8 heads of lettuce	
05 - Stabilizing base SSB1	AC019
For SD 92, SD 92 SC and EM 98	
Diameter: 360 mm / 14,2"	
Height: 170 mm / 6,7"	



DYNACUBE



01 - Dynacube complete

Total height: 330 mm / 13"
Diameter: 400 mm / 15,75"
Weight / shipping weight: 3,1 Kg / 6,8 lbs - 4,4 Kg / 9,7 lbs

The perfect manual kitchen tool. Simple and practical to use for rapidly and efficiently dicing vegetables. It's safe patented grid system made with surgical stainless steel blades ensures a clean consistent cut of vegetables, fruit and cooked meats. Great for soft vegetables.



- CL005
- CL003
- CL006
- CL008
- CL009

Dynacube complete	AC060	AC061	AC062	AC063	AC064
Grid set 7 x 7mm / 1/8" x 1/8" with pusher					
Grid set 8,5 x 8,5mm / 1/4" x 1/4" with pusher					
Grid set 10 x 10mm / 3/8" x 3/8" with pusher					
Grid set 14 x 14mm / 1/2" x 1/2" with pusher					
Grid set 17 x 17mm / 3/4" x 3/4" with pusher					
	•	•	•	•	•

Sizes are estimates only.

02 - Dynacoupe without discs	CL001
Total height: 260 mm / 10,25"	
Diameter: 370 mm / 14,5"	
Actual weight / shipping weight: 2,1 Kg / 4,6 lbs - 2,8 Kg / 6,2 lbs	
Very simple and easy to use. Ideal for quickly and efficiently slicing and shredding vegetables. Discs sold separately.	
Dynacoupe with 2 discs	CL002
Slicing disc: thickness 3 mm / 1/8"	
Shredding disc: holes 3 mm / 1/8"	
03 - Storage rack A 6-disc-capacity storage rack.	AC025

Slice and shred with ease. The Dynacoupe is ideal for manually slicing and shredding vegetables. This unit is easy to clean and the discs are easily interchangeable.

DYNACOUBE

Additional discs available

04 - Slicing discs	
Thickness - 1,5 mm x Ø 220 mm - 1/64"	AC015
Thickness - 2 mm x Ø 220 mm - 5/64"	AC012
Thickness - 3 mm x Ø 220 mm - 1/8"	AC013
Thickness - 5 mm x Ø 220 mm - 3/16"	AC014
05 - Shredding discs	
Ø holes - 2 mm x Ø 220 mm - 5/64"	AC020
Ø holes - 3 mm x Ø 220 mm - 1/8"	AC021
Ø holes - 4 mm x Ø 220 mm - 5/32"	AC022





USA

1320 ROUTE 9 #1352
CHAMPLAIN, NY - 12919
PHONE (800) 267-7794
FAX (877) 668-6623
INFO@DYNAMICMIXERS.COM
DYNAMICMIXERSUSA.COM

CANADA

3227 BOUL. PITFIELD
MONTRÉAL, QUÉBEC - H4S 1H3
PHONE (514) 956-0127 / (800) 267-7794
FAX (877) 668-6623
INFO@DYNAMICMIXERS.COM
DYNAMICMIXERS.CA